



# MODEL VCD-M

Project:
Tag:
Engineer:
Contractor:
Date:

## Motorized Multi-Leaf Damper

### DAMPER PARTS

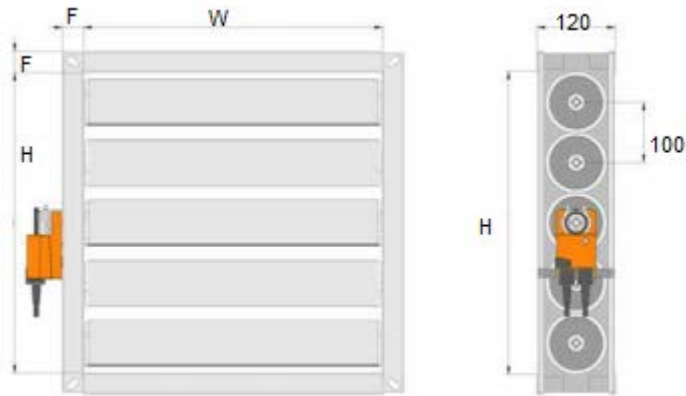
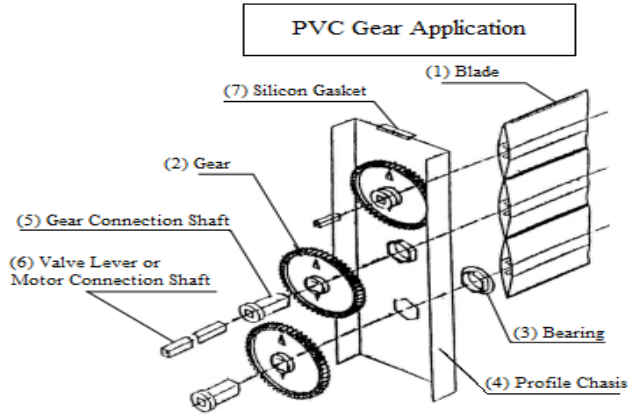

<b>W (mm)</b>	200	300	400	500	600	700	800	900	1000	1100	1200	1300	1400	1500
<b>H (mm)</b>	200	300	400	500	600	700	800	900	1000					
<b>F (mm)</b>	30													

\* all dimensions are mm.

As part of our continuous improvement program, we reserve the right to make further improvements without notice.

				Date submitted:
--	--	--	--	-----------------



# MODEL VCD-MB

## Motorized Multi-Leaf Damper

Project:

Tag:

Engineer:

Contractor:

Date:

### Volume Damper with Latch Command

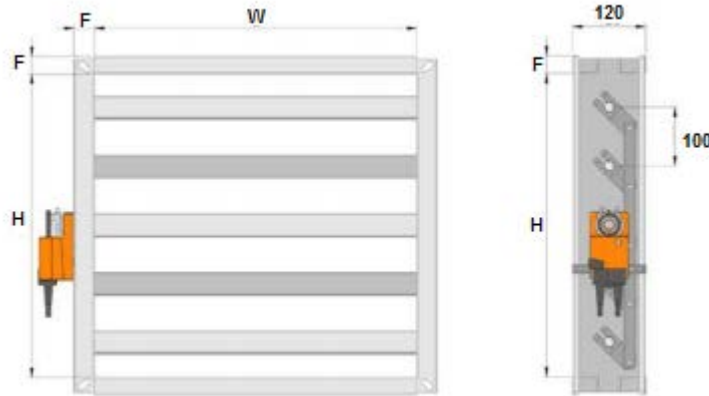

<b>W (mm)</b>	200	300	400	500	600	700	800	900	1000
<b>H (mm)</b>	200	300	400	500	600	700	800	900	1000

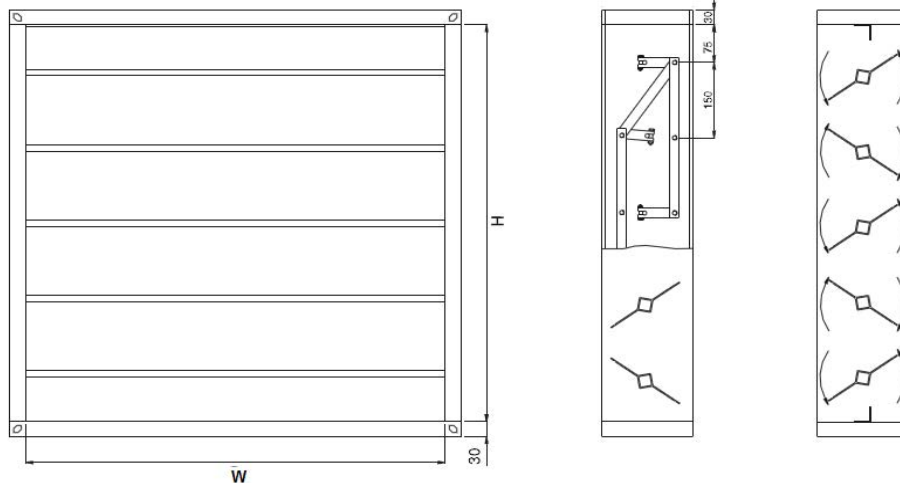

OVAL SPIGOT

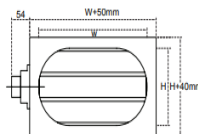
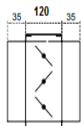

ROUND SPIGOT

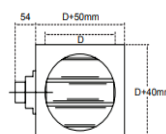
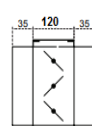

RECTANGULAR - SQUARE SPIGOT

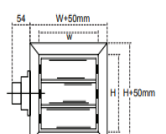
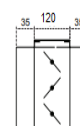

\* all dimensions are mm.

As part of our continuous improvement program, we reserve the right to make further improvements without notice.